

Sewing guidelines for knitted textiles

Working with knitted textiles

Knitted upholstery textiles offer new ways to create spaces. While woven textiles are currently the most commonly used surface material for interiors, a knitted textile lend itself to easy upholstering of furniture and objects with organic shapes because of the inherent stretch.

A knitted textile is constructed of loops that allow the yarns freedom to move and thereby stretch more easily than warp and weft weaves. It is important to understand the material to take advantage of the special properties of knits and avoid challenges when processing the textile. If you replace a woven textile with a knitted textile on a specific design, it is necessary to consider how the knitted construction affects the size of the pattern and the processing in order to achieve the desired result.

Please note that the following text contains recommendations only. Proper sewing tests should always be conducted prior to production in order to assure the best result.

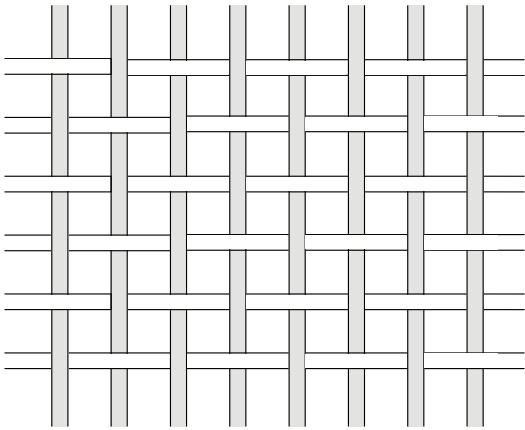

Weaving structure

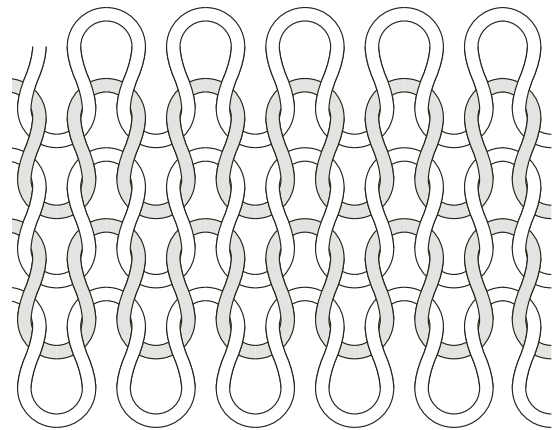

Knitting structure

Sewing

Knitted textiles should always be handled with care. Before starting the sewing process, make sure you have a clean workplace free of any dirt, dust and sharp objects.

Both thin and padded knitted textiles should be overlocked along the edges after the pieces have been cut. The overlock will prevent the filling coming out of the padded textiles and make it easier to handle.

Choosing the right needle, thread and general machine settings is essential to achieve a good result.

Choice of needle

Always use a ballpoint needle, preferably a SUK needle. This type of needle has a rounded tip, which allows the needle to move between the yarns instead of piercing them. The recommended needle size is NM100 or NM110.

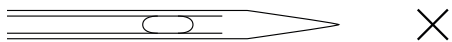

Regular needle

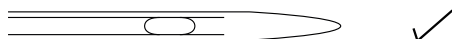

Ballpoint needle

Note that the risk of damaging the yarns increases with the thickness of the needle. We always recommend using a NM 110 SUK needle for padded textiles, as needles are more easily damaged because of the volume of the textile.

Be reminded that the needles should be checked and changed regularly. If the needle is damaged, it is more likely to cause holes in the textile. The holes around the seam will become visible as soon as the textile is tensioned.

To check if the needle is damaged, gently move it over one of your nails. If the needle scratches your nail, it will have to be replaced.

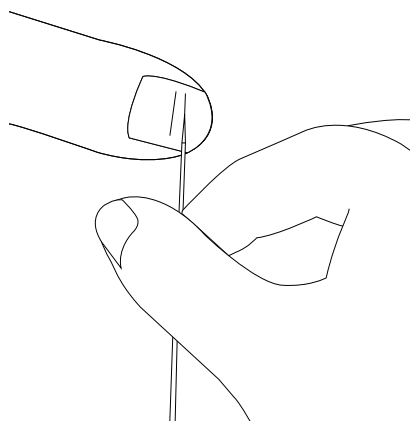

Example of damaged needle

Choice of thread

The appropriate thickness of the thread depends on needle of choice. 40/3 threads will be suitable for the needles recommended above.

Nylon and polyester threads are recommended.

Machine settings

The correct stitch length should result in 2.5 to 3 stitches per centimetre (approx. 6–7 stitches per inch). A short stitch length will often make for a strong seam, but too short and tight stitches may increase the risk of creating weak spots in the textile, especially when working with the padded textiles.

The tension of the bottom thread should be 3 to 4 times higher than the tension of the top thread. The feeding system for the thread should be automated so the thread is fed by itself and not pulled out of the carrier.

The sewing machine should have both top and bottom feeder transport for the textile. Sewing on machines with top feeder system only may cause uneven tension between the layers of textile.

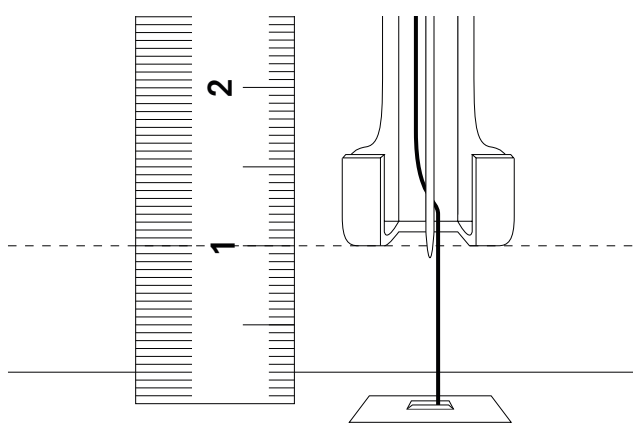

Foot height sewing machine

When working with the padded textiles, the recommended foot height is 10 mm to ensure that the textile has enough space.

Wallcovering

If knitted textiles are chosen for wallcovering, always use a panel or screen. The textiles should never be upholstered directly on the wall.

If the panels or screens are upholstered by only fixating the textile along the edges, please consider the amount of tension the textile is subjected to. Upholstering with tension is only possible on small surfaces (less than 2m²). When using staples or nails for the upholstering, do not get too close to the edge, as the sharp metal may cause small damages in the textile, which will become visible holes.

For big surfaces (more than 2m²), it is recommended to glue the textile to the panel/screen with a water based two-component glue. When using glue to fixate the textile, the textile should not be tensioned.

To mount the textile on the panel or screen, start by fixating the corners and then move along the sides to attach the textile. Always keep an eye on the direction and pattern of the textile to ensure a beautiful result.

Openings for wall fixtures

If it is necessary to make openings for wall fixtures in the textile surface, it is always recommended to upholster using glue. The openings should be prepared before the panel or screen is installed. If there is any tension in the textile surface, it will not be possible to make controlled openings in the textile.

Recommended method for making openings in the textile surface:

1. Mark the cutting lines. The cutting lines should be slightly shorter than the required opening to allow the textile to stretch and shape itself around the wall fixture.
2. Apply transparent silicone so it covers the cutting lines on both front and back of the textile. The silicone has to be completely dry before cutting in order to keep the textile from unravelling.
3. Once the opening has been cut, fold the edges towards back.

————— Size the hole needs to be

■ Silicone area

- - - - - Cutting lines

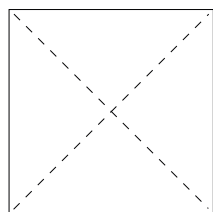

1

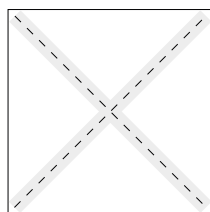

2

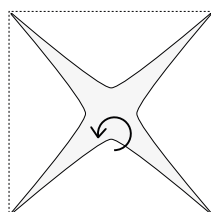

3

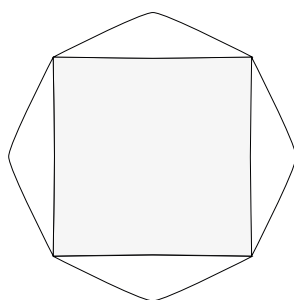
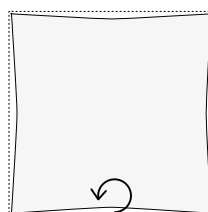

View from the back